

Union Ceiling Fan

CRAFTMADE
air • light • sound

P.O. Box 1037
650 S. Royal Lane, Suite 100
Coppell, TX 75019

(800) 486-4892
8:00 to 5:00 CST (Central Standard Time)
Toll Free Fax: (877) 304-1728

email: customerservice@craftmade.com
www.craftmade.com

CRAFTMADE
air • light • sound

P.O. Box 1037
650 S. Royal Lane, Suite 100
Coppell, TX 75019 EE.UU.

(800) 486-4892
8:00 a 5:00 CST (Hora local central)
Número de fax sin cargo: (877) 304-1728

Correo electrónico: customerservice@craftmade.com
www.craftmade.com

CRAFTMADE
air • light • sound

P.O. Box 1037
650 S. Royal Lane, Suite 100
Coppell, TX 75019 EE.UU.

de 8 heures à 17 heures (Heure standard du centre)
Numéro de télécopieur gratuit : (877) 304-1728

Email: customerservice@craftmade.com
www.craftmade.com

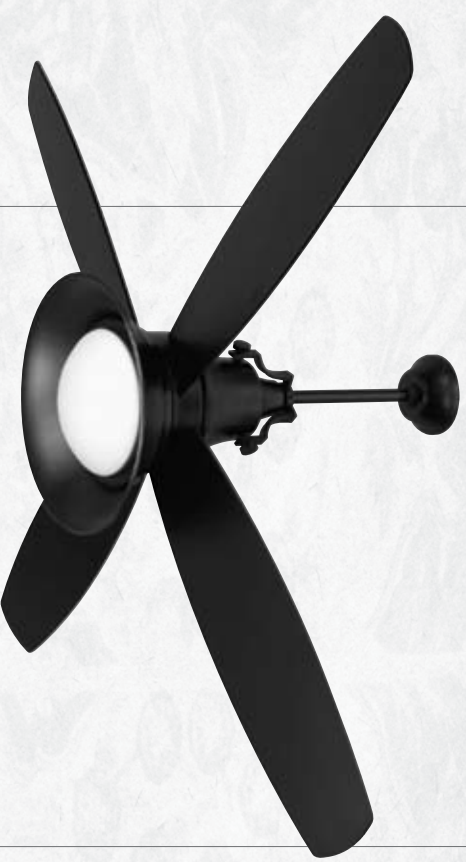

UN52

Installation Instructions
Instrucciones de instalación
Instructions d'installation

CRAFTMADE
air • light • sound

Read and Save These Safety Precautions

1. Turn off electricity at main switch before wiring or servicing fan in order to avoid possible electrical shock.
2. All wiring must be in accordance with the National Electric Code (ANSI/NFPA70-1999) and local electrical codes. Electrical installation should be performed by a qualified licensed electrician.
3. After making the wire connections, the wires should be spread apart with the grounded conductor and the equipment-grounding conductor on the one side of the outlet box and the ungrounded conductor on the other side of the outlet box.
4. The splices after being made should be turned upward and pushed carefully up into the outlet box.
5. Conductor of a fan identified as grounded conductor to be connected to grounded conductor of power supply, conductor of a fan identified as ungrounded conductor to be connected to an ungrounded conductor of power supply, conductor of fan identified for equipment grounding to be connected to an equipment-grounding conductor.
6. To reduce the risk of fire, electric shock or personal injury, mount to outlet box marked "Acceptable for Fan Support" and use mounting screws provide with the outlet box. The outlet box and its support must be able to support the moving weight of the fan (at least 35lbs)
7. **WARNING:** To reduce the risk of fire or electric shock, use this fan only with solid state speed control device provided.
8. Wall switch, model UC9787TB, the switch have been investigated and found acceptable for use as a fan speed control.
9. **WARNING:** To reduce the risk of personal injury, do not bend the blade brackets when installing the brackets, balancing the blades or cleaning the fan. Do not insert foreign objects in between rotating fan blades.
10. **Weight:** The weight of the complete fan, including assembly hardware is 17.6 lbs.

Trouble Shooting

Problem A: Fan Will not Start

Remedies:

1. Check fuse or circuit breaker and replace if necessary.
2. Turn off electrical power and check all wire connectors.
3. Check on/off/TCS and wall control selector switch. See operation instructions.

Problem B: Fan is Excessively Noisy

Remedies:

1. Check that all screws in fan assembly are tight and properly seated.
2. Check to make sure mounting bracket is installed properly.
3. Check to make sure light kit and glass are installed properly and tight.
4. If wall control is used, insure the wall control is not a transformer or a variable speed type.

Problem C: Fan Wobbles

Remedies:

1. Check that all blades are screwed firmly into blade holders.
2. Check that all blade holders are screwed firmly into motor.
3. Check the weight of blades. All our blades are weighed on electronic scales. The weight is marked on the reverse side of the fan blade near the motor end. All of the blades should be the same weight to prevent fan from wobbling.
4. A balancing kit is enclosed if needed.









Before Assembly

1. Make sure that the fan voltage (120) is compatible with your own electrical system.
2. Check to make sure that your carton contains all the parts mentioned in the parts list.
NOTE: The box can be used as a work space to prevent any damage on the ornamental surface.
CAUTION: Before installing, choose a location for mounting the fan where the blades have at least 7 feet of clearance from all objects and floor. Mount an outlet box to the ceiling or use an existing box.
CAUTION: Do not mount fan to sheet rock or drywall type materials. To insure proper support, use the two #1 wood screws to secure mounting bracket to joist or beam. If the location you choose does not have a suitable support beam, install a 2"x 4" brace between ceiling joists to support.

Screw Package

- S1. Wood Screws & Washers
- S2. Bracket Screws & Washers
- S3. Blade Screws & Rubber Washers
- S4. Wire Connectors
- S5. Safety Bolt & Nut
- S6. "J" Hook
- S7. Zip Tie
- S8. Screw and Nut for Safety Cable







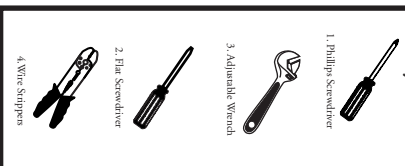







Quantity

Hardware Inventory	Quantity
	2
	2
	13
	3
	1
	1
	1
	1

Tools you Need



What You Have

Parts	Quantity
	1
	1
	1
	1
	1
	1
	1
	1
	1
	1
	2
	4
	1
	1

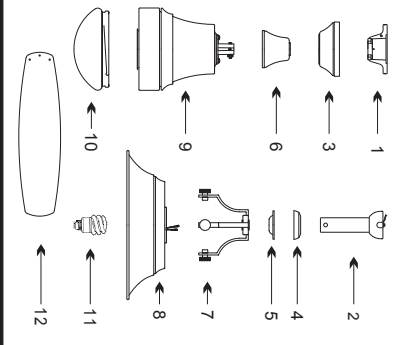

Turn off circuit breakers and wall switch to the fan supply line leads.



Preparation

Important: When using an existing outlet box, be sure the box is securely attached to the building structure and can support the full weight of the fan. Failure to do so can result in serious injury or death.

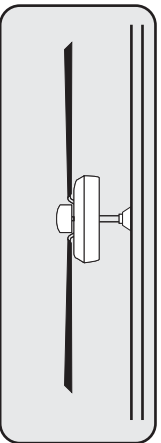

a.) Downrod Mount
(Normal Ceilings)

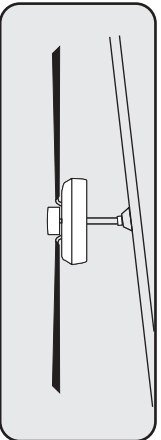

b.) Angle Mount
(Vaulted Ceilings)

IMPORTANT: If using the angle mount method, check to make sure the ceiling angle is not steeper than 35°. Angles greater than 35° will require a 45° angle adapter.

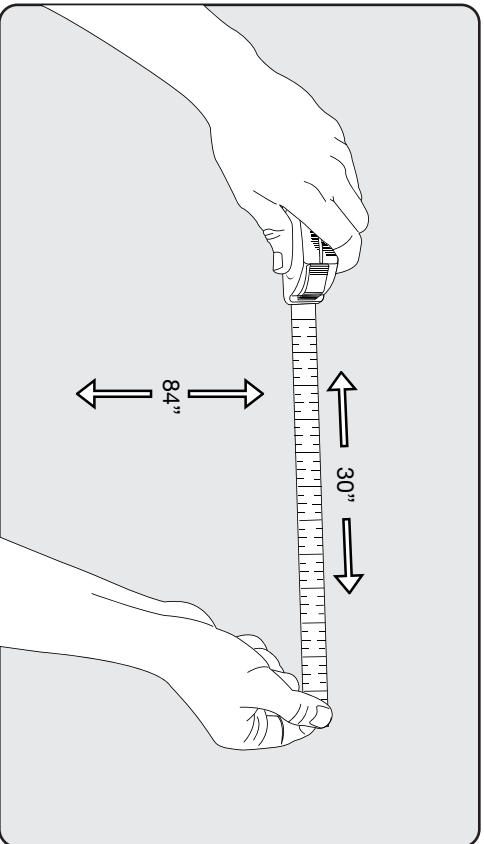

- Check to make sure blades are at least 30" from any obstruction.
- Check Down rod Length to make sure blades are at least 7' above the floor.

Installing Mounting Bracket

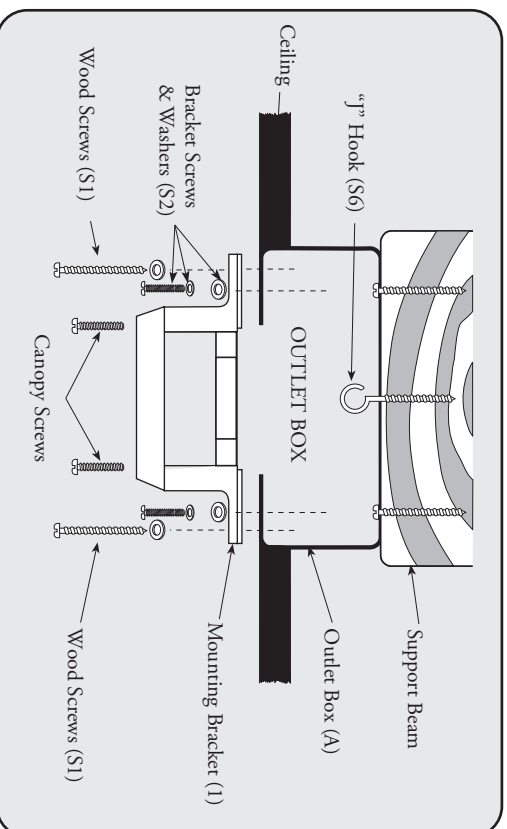

NOTE: Do not mount directly to sheetrock or ceiling tile.

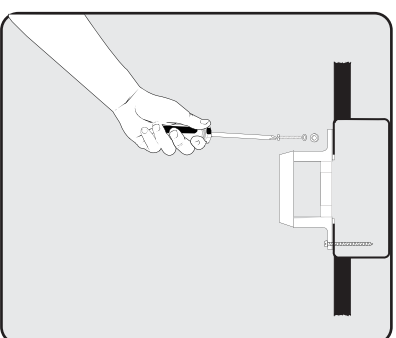
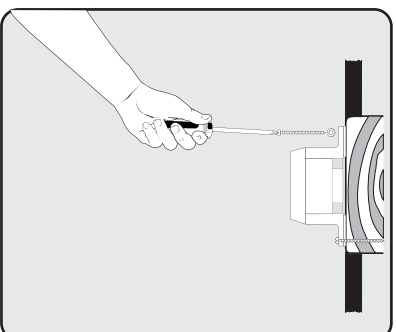

Prior to securing mounting bracket, screw "J" hook (S6) into ceiling outlet box as a secondary support means. Secure mounting bracket (#1) to the outlet box (A) by tightening bracket screws & washers (S2) as shown. If not mounting to an outlet box, use wood screws (S1) and washers (S1) and mount securely to ceiling beam. Be sure at this point to insert canopy screws in bracket.

5

Downrod Assembly

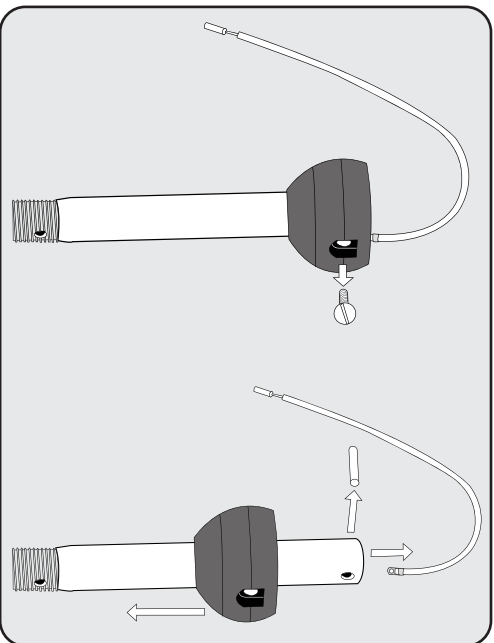

Locate downrod assembly (#2). Loosen ball screw on black hanging ball to free lock pin. Black hanging ball will slide down. Remove ground screw and green ground wire. Remove hanging ball from downrod and save all parts. Insert fan wires through downrod.

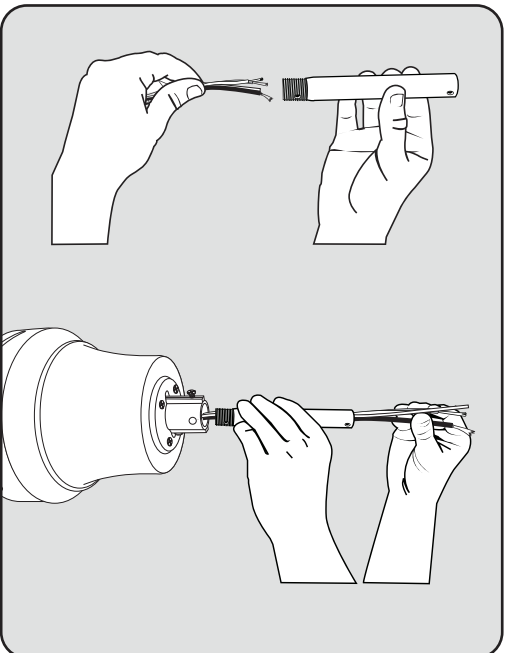

6

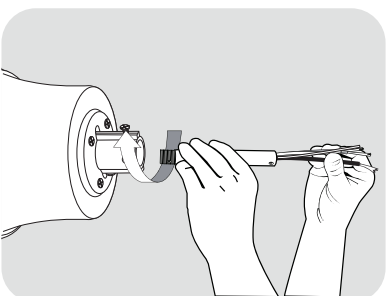

Thread the downrod onto the motor housing making sure the wires don't get twisted.

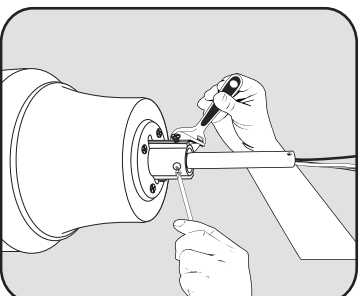

Insert safety bolt (S5) through flange & downrod and attach nut. Tighten firmly.

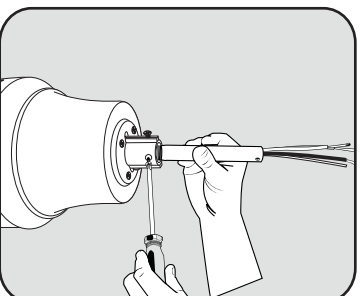

Tighten top set screw against downrod.

7

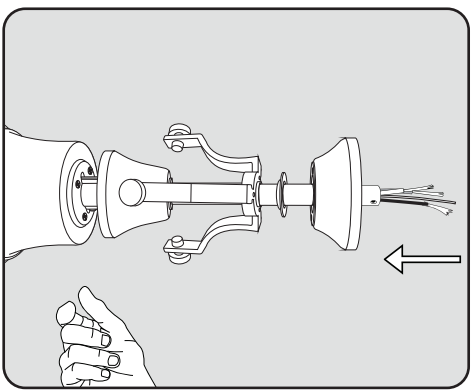

Place flange cover, downrod accessory, anti-sway adapter and canopy in order over downrod assembly.

⚠ WARNING: Failure to completely tighten downrod as described in steps above could result in the fan loosening and possibly falling.

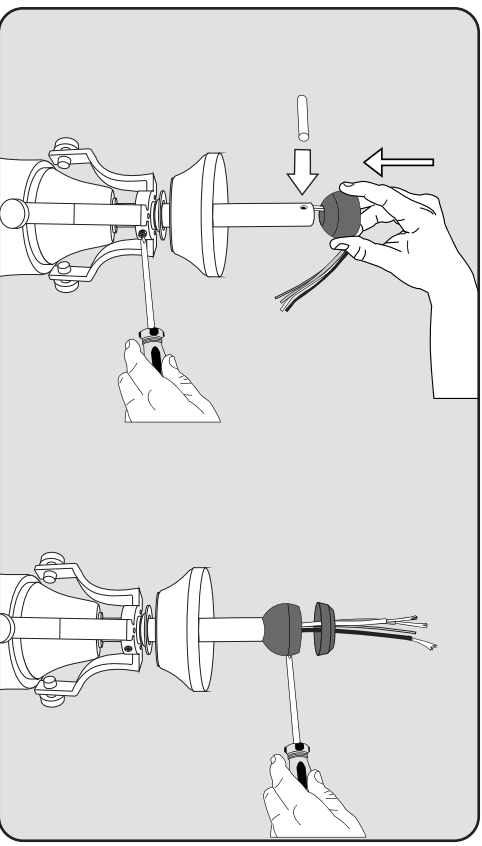

Replace hanging ball, insert hanging pin through downrod and tighten set screw through hanging ball into downrod. Secure the decorative bracket by tightening the screw on it. Thread the wire through the holes of the waterproof cover and slip the waterproof cover over the hanging ball.

8

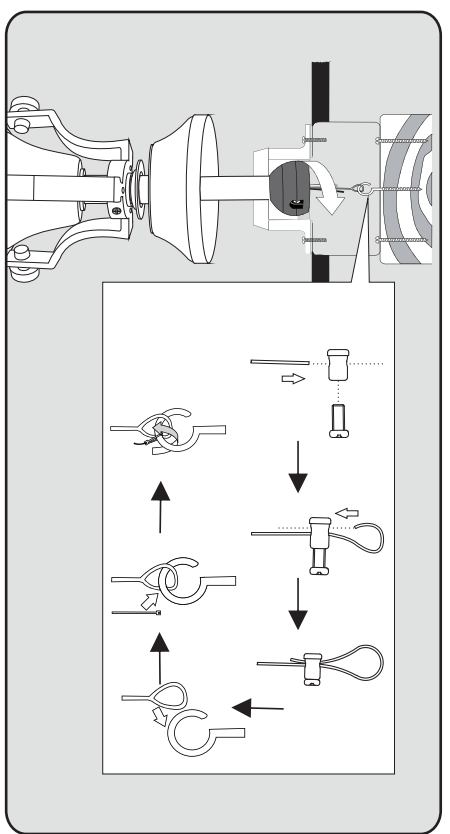

Lift fan onto the mounting bracket (#1). Turn housing until hanging ball seats itself into ball socket (listen for click).

For added security, thread the safety cable through the nut and make a ring shown on figure. Re-thread the safety cable into the nut and secure by tightening the screw. Attach safety cable from fan unit to "j" hook (S6) in outlet box. Secure by looping zip tie (S7) through safety cable and "j" hook. Tighten zip tie securely.

⚠ WARNING: To reduce the risk of fire, electric shock or personal injury, mount so outlet box marked "acceptable for fan support" and use mounting screws provided with the outlet box. Most outlet boxes commonly used for the support of lighting fixtures are not acceptable for fan support and may need to be replaced. Consult a qualified electrician if in doubt.

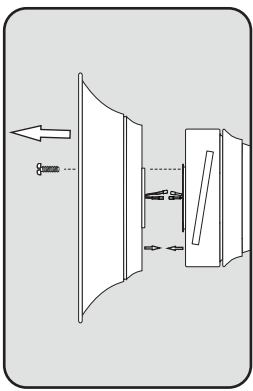

Remove one of the 3 set screws on the mounting ring and loosen the other two screws. Do not remove.

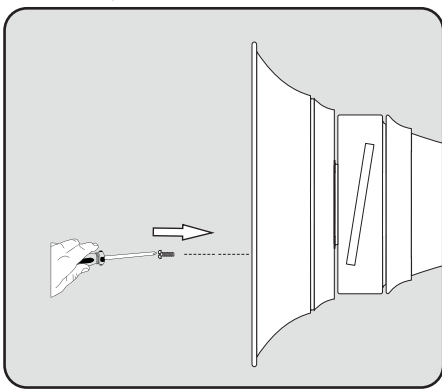

While holding the light kit assembly under your fan, snap together the wire connection plugs.
Align the key holes of the mounting plate with the loosened screws and tighten all 3 screws securely.

Install 2 x 13W CFL bulbs (included)

Twist the glass into the light plate securely.

